

GR Επίγεια Ψηφιακή Κεραία UHF 5G LTE 21-48

UK Digital Terrestrial Antenna UHF 5G LTE 21-48

DE Digitale Terrestrische Antenne UHF 5G LTE 21-48

ES Antena Digital Terrestre UHF 5G LTE 21-48

IT Antenna Digitale Terrestre UHF 5G LTE 21-48

FR Antenne Terrestre Numérique UHF 5G LTE 21-48

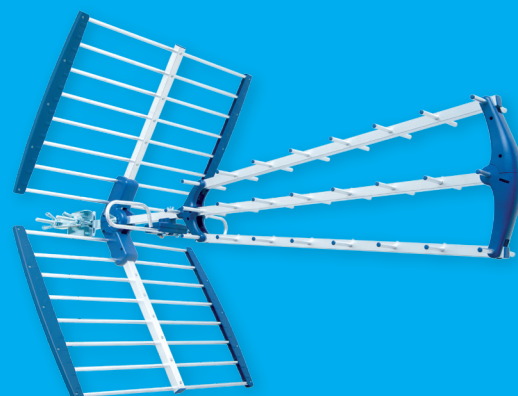

Τεχνικά Χαρακτηριστικά / Technical Data / Technische Daten / Características Técnicas / Caratteristiche Tecniche / Données Techniques

Μοντέλο / Model / Modell / Modelo / Modello / Modèle	TALOS 18dB
Τύπος Κεραίας / Antenna type / Antennentyp / Tipo de antena / Tipo di antenna / Type d'antenne	UHF
Κανάλια λήψης / Channels / Kanäle / Canales / Canali / Chaînes	21-48
Φάσμα συχνοτήτων λήψης / Frequency Range / Frequenzbereich / Rango de frecuencia / Gamma di frequenza / Gamme de fréquences	470-694Mhz
Αποκοπή 5G LTE / 5G LTE Protection / 5G LTE Schutz / Protección 5G LTE / Protezione 5G LTE / Protection 5G LTE	✓
Απολαβή / Gain / Verstärkung / Ganância / Guadagno / Gain	18dB
Σύνθετη Αντίσταση / Impedance / Impedanz / Impedancia / Impedenza / Impédance	75Ω
Διάμετρος ιστού στερέωσης / Mast Diameter Support / Mastdurchmesser Unterstützung / Soporte de diámetro de mástil / Supporto diametro albero / Support de diamètre de mât	20...50mm
Εφαρμογή / Application / Anwendung / Aplicación / Applicazione / Application	Outdoor
Χρώμα / Color / Farbe / Color / Colore / Couleur	Μπλε / Blue / Blau / Azul / Blu / Bleu
Μήκος / Length / Länge / Longitud / Lunghezza / Longueur	105cm
EAN Barcode	5200378402894
Συσκευασία / Packing / Verpackung / Embalaje / Imballaggio / Emballage	Giftbox
Ποσότητα συσκευασίας / Packing Quantity / Verpackungsmenge / Quantité d'emballage / Quantità di imballaggio / Quantité d'emballage	10pcs

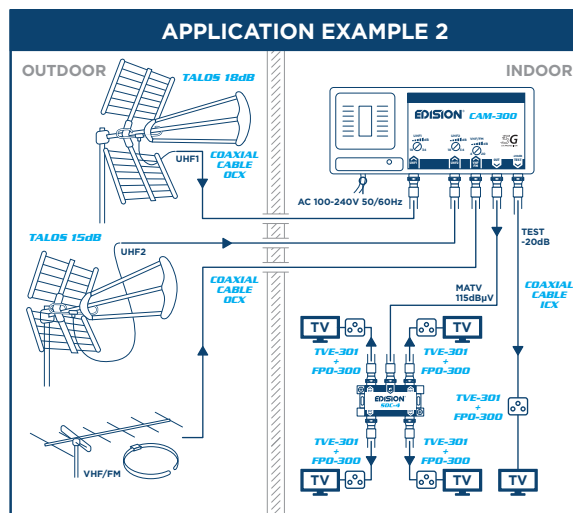
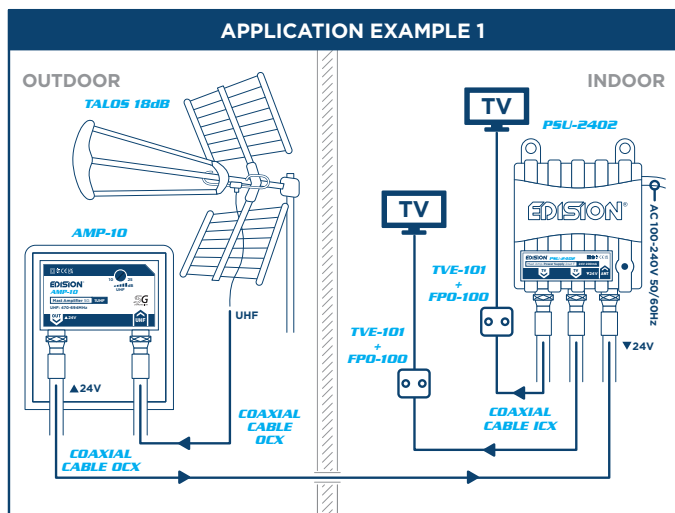

TALOS 18db

Digital Terrestrial Antenna UHF 5G LTE (21-48)

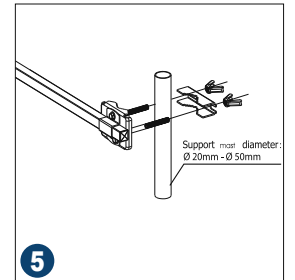
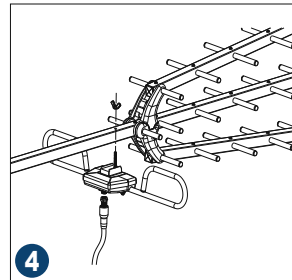
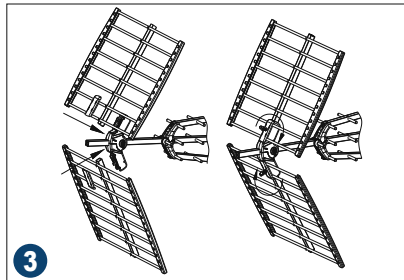
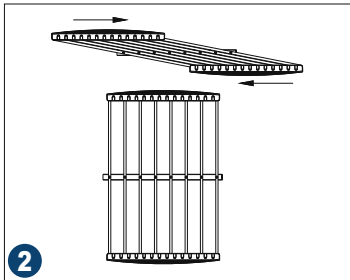
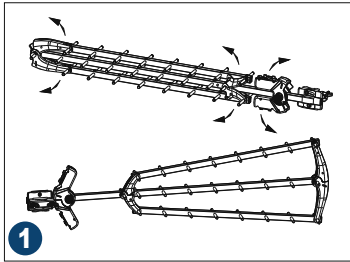
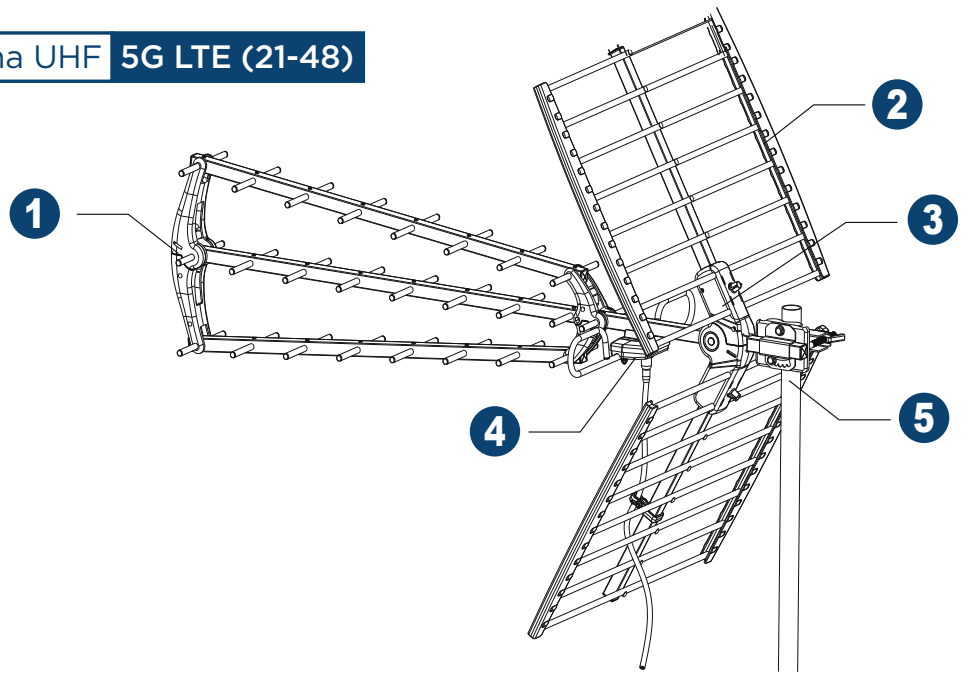

GR Για περισσότερες πληροφορίες, παρακαλώ επικοινωνήστε στο support@edision.gr ή στο DOWNLOAD CENTER: www.edision.gr/el/support

UK For more information, please contact support@edision.gr or visit the DOWNLOAD CENTER: www.edision.gr/en/support

DE Für mehr Informationen, bitte wenden Sie sich an support@edision.gr oder im DOWNLOAD CENTER: www.edision.gr/de/support

ES Para más información, contáctate support@edision.gr o visita el CENTRO DOWNLOAD: www.edision.gr/en/support

IT Per maggiori informazioni, veuillez contacter support@edision.gr oppure visitare il DOWNLOAD CENTER: www.edision.gr/en/support

FR Pour plus d'informations, veuillez contacter support@edision.gr ou visitez le DOWNLOAD CENTER: www.edision.gr/en/support



GR Το πιστοποιητικό CE του προϊόντος είναι διαθέσιμο στην ιστοσελίδα μας, στον σύνδεσμο: www.edision.gr/el/support

UK The CE certificate of the product is available on our webpage, by visiting this link: www.edision.gr/en/support

DE Das CE Zertifikat des Produktes finden Sie auf unserer Website unter: www.edision.gr/en/support

ES El certificado CE del producto está disponible en nuestra página web, visitando este enlace: www.edision.gr/en/support

IT Il certificato CE del prodotto è disponibile sulla nostra pagina web, visitando questo link: www.edision.gr/en/support

FR Le certificat CE du produit est disponible sur notre page web, en visitant ce lien: www.edision.gr/en/support

